

Varenummer: 201241459

Beskrivelse: E+G Stangmagnet m/gevindtap GN 52.4-AN-40-M8-E  
Alu, Nikkel, Kobolt - 450° C, 240N

## Mål

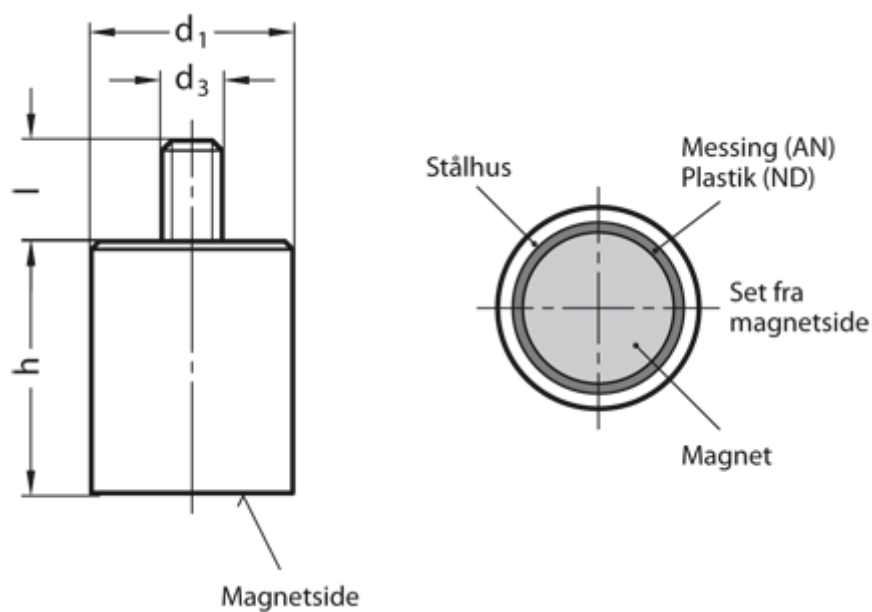

d1	= 40
d3	= M8
h	= 50 ±0,2
Holdekraft N	= 240.0
l	= 15
Materiale	= AN Alu, Nikkel, Kobolt - 450° C